

KrosFlo® TFF System - Auxiliary Scale Model ACSS-20K

User Guide

For use with:

- KrosFlo® KR2i Tangential Flow Filtration (TFF) System
- KrosFlo® KMPi Tangential Flow Filtration (TFF) System



The information contained in this document is subject to change without notice.

Repligen Corporation makes no warranty of any kind with regards to this material, including, but not limited to, the implied warranties of merchantability and fitness for a particular purpose.

Repligen Corporation shall not be liable for errors contained herein or for incidental or consequential damages in connection with the furnishing, performance, or use of this material.

No part of this document may be photocopied, reproduced, or translated to another language without the prior written consent of Repligen Corporation.

Products are not intended for diagnostic or therapeutic use or for use in vivo with humans or animals.

For further information, please contact Repligen Corporation at www.repligen.com.

©2020 Repligen Corporation. All rights reserved. The trademarks mentioned herein are the property of Repligen Corporation and/or its affiliate(s) or their respective owners.

Customer Support

customerserviceUS@repligen.com

310-885-4600

Repligen Corporation

18617 South Broadwick Street

Rancho Dominguez, California 90220

www.repligen.com

Contents

| | |
|---|-----------|
| 1. General precautions | 7 |
| 2. KrosFlo® TFF System – Auxiliary Scale | 7 |
| 2.1 System assembly | 8 |
| 2.2 Operating instructions | 10 |
| 2.2.1 Operational panel | 10 |
| 2.2.2 Operating the auxiliary scale | 11 |
| 3. Weighing | 12 |
| 3.1 Good weighing practice | 12 |
| 3.2 Zeroing | 12 |
| 3.3 Taring | 12 |
| 3.3.1 Entering tare value manually | 13 |
| 3.4 Units | 13 |
| 3.4.1 Start unit | 13 |
| 3.4.2 Temporary unit | 13 |
| 4. Calibration | 13 |
| 4.1 External calibration | 14 |
| 4.2 User calibration | 14 |
| 4.3 Calibration report | 14 |
| 5. Scale parameters | 14 |
| 5.1 Filter | 14 |
| 5.2 Value release | 15 |
| 5.3 Ambient conditions | 15 |
| 5.4 Autozero function | 15 |
| 5.5 Tare entering mode | 15 |
| 5.6 Tare value memory | 15 |
| 5.6.1 Entering tare value to scale memory | 15 |
| 5.6.2 Selecting tare value from the scale memory | 16 |
| 5.7 Last digit | 16 |
| 6. Communication | 16 |
| 6.1 RS232 (1) port settings | 16 |
| 6.2 USB (A) port | 16 |
| 6.3 USB (B) port | 17 |
| 7. Peripheral devices | 17 |
| 7.1 Computer | 17 |
| 7.1.1 Port | 17 |
| 7.1.2 Continuous transmission | 17 |
| 7.1.3 Printout interval for continuous transmission | 17 |
| 7.1.4 Printer | 17 |
| 7.1.5 Port | 18 |
| 7.2 Additional display | 18 |
| 7.2.1 Port | 18 |
| 8. Printouts | 18 |
| 8.1 Calibration report | 18 |
| 8.2 GLP printout | 19 |
| 9. Miscellaneous parameters | 19 |
| 9.1 Backlight | 19 |
| 9.2 ‘Beep’ sound | 20 |
| 9.3 Automatic shutdown | 20 |
| 9.4 Date and time | 20 |
| 9.5 Default user settings | 20 |
| 10. Scale Data | 21 |
| 11. Working modes – General information | 21 |
| 11.1 Running working mode | 21 |

| | | |
|------------|---|-----------|
| 11.2 | Working mode local settings | 21 |
| 11.2.1 | Working mode accessibility | 22 |
| 11.2.2 | Save mode..... | 22 |
| 11.2.3 | Automatic printout interval | 22 |
| 11.2.4 | Lo threshold | 23 |
| 12. | Working mode – Weighing..... | 23 |
| 12.1 | Local settings | 23 |
| 13. | Working mode – Parts Counting..... | 23 |
| 13.1 | Local settings | 23 |
| 13.1.1 | Working mode selection..... | 24 |
| 13.2 | Setting reference sample mass by entering mass of a single part | 24 |
| 13.3 | Setting reference sample mass by determining mass of a single part..... | 24 |
| 14. | Working mode – +/- control | 25 |
| 14.1 | Local settings | 25 |
| 14.2 | Declaring check weighing thresholds | 25 |
| 15. | Working mode – Percent Weighing | 25 |
| 15.1 | Local settings | 25 |
| 15.1.1 | Working mode selection..... | 26 |
| 15.2 | Reference mass determined by weighing | 26 |
| 15.3 | Reference sample mass by determining mass of a single part | 26 |
| 16. | Working mode – Peak Hold | 26 |
| 16.1 | Local settings | 26 |
| 16.2 | Peak Hold operation | 27 |
| 17. | Totalizing | 27 |
| 17.1 | Local settings | 27 |
| 17.2 | Totalizing operation..... | 27 |
| 18. | Working mode – Animal Weighing | 28 |
| 18.1 | Local settings | 28 |
| 18.2 | Animal Weighing operation..... | 28 |
| 19. | Maintenance | 29 |
| 19.1 | Cleaning ABS components..... | 29 |
| 19.2 | Cleaning stainless steel components..... | 29 |
| 19.3 | Cleaning aluminum components..... | 29 |
| 20. | Mechanical design | 30 |
| 20.1 | Dimensions | 30 |
| 20.2 | Connectors arrangement..... | 30 |
| 21. | Troubleshooting | 31 |
| 22. | Error messages | 31 |
| 23. | Index..... | 32 |

List of tables

| | | |
|-----------|---|----|
| Table 1. | KrosFlo® TFF System – Auxiliary Scale parts | 7 |
| Table 2. | Auxiliary scale keys | 10 |
| Table 3. | Auxiliary scale menu | 11 |
| Table 4. | Auxiliary scale menu navigation | 11 |
| Table 5. | Good weighing practices | 12 |
| Table 6. | Calibration report variable list..... | 18 |
| Table 7. | GLP weighing printout variable list..... | 19 |
| Table 8. | GLP date and time printout variable list..... | 20 |
| Table 9. | Scale Data | 21 |
| Table 10. | Working mode settings | 22 |
| Table 11. | Save mode options | 22 |
| Table 12. | Weighing – Local settings | 23 |
| Table 13. | Parts Counting – Local settings..... | 23 |
| Table 14. | +/- control – Local settings | 25 |
| Table 15. | Percent Weighing – Local settings..... | 26 |
| Table 16. | Peak Hold – Local settings | 27 |
| Table 17. | Totalizing – Local settings..... | 27 |
| Table 18. | Animal Weighing – Local settings..... | 28 |
| Table 19. | Troubleshooting suggestions..... | 31 |
| Table 20. | Error messages | 31 |

List of figures

| | | |
|------------|---|----|
| Figure 1. | KrosFlo® TFF System - Auxiliary Scale components..... | 7 |
| Figure 2. | Auxiliary scale parts | 7 |
| Figure 3. | Grounding spring check..... | 8 |
| Figure 4. | Rubber feet installation | 8 |
| Figure 5. | Weighing pan installation..... | 9 |
| Figure 6. | Leveling the scale | 9 |
| Figure 7. | Interface cable to scale connection..... | 9 |
| Figure 8. | Interface cable to octopus cable | 10 |
| Figure 9. | Auxiliary scale keypad | 10 |
| Figure 10. | Calibration report example | 19 |
| Figure 11. | GLP printout example..... | 19 |
| Figure 12. | Totalizing printout example | 28 |
| Figure 13. | Scale dimensions | 30 |
| Figure 14. | Scale connectors..... | 30 |
| Figure 15. | RS-232 connector | 30 |

Abbreviations

| | |
|------|------------------------|
| Acc | Access |
| CAL | Calibration |
| CdF | Calibration difference |
| Conn | Communication |
| CtP | Calibration type |
| dSh | Dashed |
| dAt | Date |
| ducE | Peripheral devices |
| Err | Error |
| Func | Function |
| InFo | Information |
| Int | Interval |
| Lo | Low |
| Othr | Other |
| Prnt | Printouts |
| rEAd | Readout |
| SiG | Signature |
| tin | Time |

KrosFlo® TFF System – Auxiliary Scale

The KrosFlo® TFF System – Auxiliary Scale assembly and operation may vary based on application. The instructions below are for general use. For questions about specific application set up or customization, please contact your local Repligen representative.

Figure 1. KrosFlo® TFF System – Auxiliary Scale components

1. Display and operations keypad
2. Weighing pan



1. General precautions

- Remove the contents from the packaging. If a part is missing, contact Repligen for replacement
- Prior to the first use, carefully read this User Guide. Use the device only as intended
- Scales to be decommissioned must be decommissioned in accordance with valid legal regulations

2. KrosFlo® TFF System – Auxiliary Scale

Table 1. KrosFlo® TFF System – Auxiliary Scale parts

| Part description | Quantity |
|-------------------------|----------|
| ACSS-20K scale | 1 |
| Weighing pan | 1 |
| Solid rubber foot | 3 |
| Rubber foot with spring | 1 |
| 3' Interface cable | 1 |

Figure 2. Auxiliary scale parts

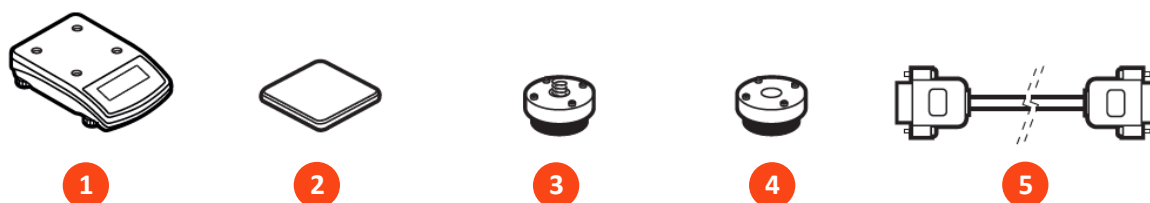

1. ACSS-20K scale
2. Weighing pan
3. Rubber foot with spring
4. Solid rubber foot
5. 3' Interface cable

1. Place the balance on a solid surface to ensure stability. Operate the balance in a room where the temperature ranges between 10 - 40° C (50 - 104° F).
2. The balance must be positioned away from heat sources, magnetic fields, vibrations, and air drafts to receive stable and repeatable results. Balance is to not be used for explosive materials.

2.1 System assembly

1. Check the grounding spring located in the rubber foot with spring. The spring must jut slightly out of the hole.

Figure 3. Grounding spring check

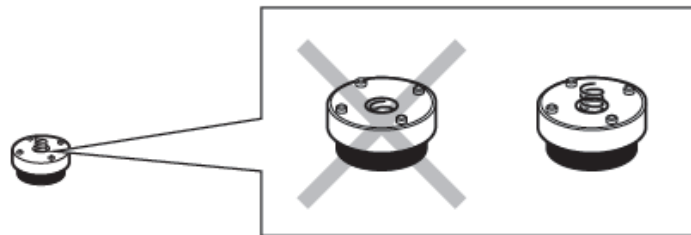

2. Install the rubber foot with spring into any freely selected opening. Install 3 x solid rubber feet in remaining openings.

Figure 4. Rubber feet installation

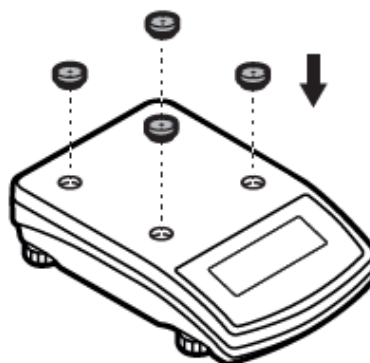

3. Install the weighing pan.

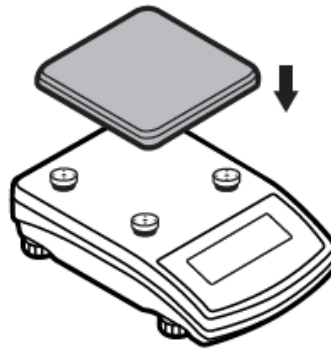
Figure 5. Weighing pan installation

- Level the scale by turning the feet and monitoring the leveling vial in the rear of the unit. Continue to adjust the feet until the air bubble takes the central position.

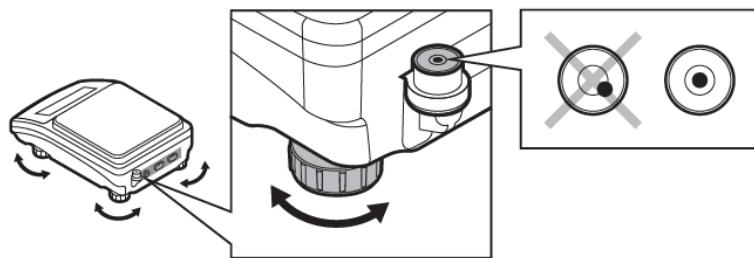
Figure 6. Leveling the scale

- Prior to switching the balance on, let it reach room temperature (estimated stabilization time: 1 - 8 hours).
- Connect the adapter cable (DB9-M) to the rear of the scale. During this process there should be no load on the weighing pan.

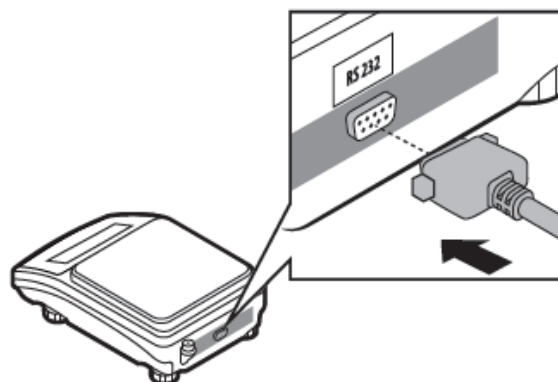
Figure 7. Interface cable to scale connection

- Connect the adapter cable (DB9-F) to the auxiliary component octopus cable.

Figure 8. Interface cable to octopus cable

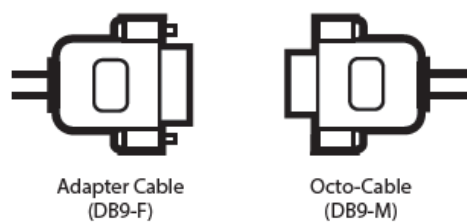

2.2 Operating instructions

2.2.1 Operational panel

Figure 9. Auxiliary scale keypad

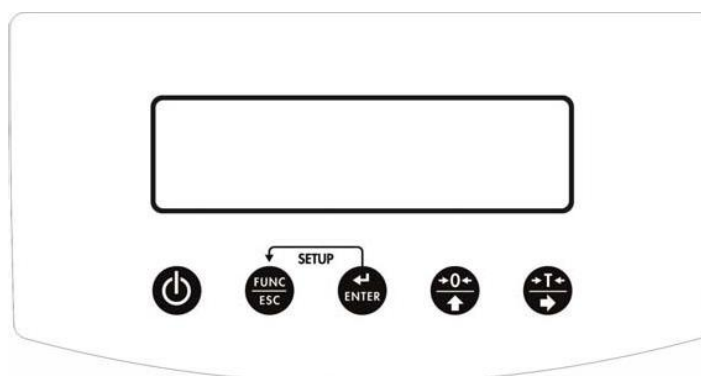







Table 2. Auxiliary scale keys

| Key | Function |
|---|--|
|  | Press to switch the weighing device on/off – hold the key for about 1 second |
|  | Function key, press to change the working mode |
|  | Press to send the weighing result to a printer or a computer |
|  | Press to zero the scale |
|  | Press to tare the scale |











2.2.2 Operating the auxiliary scale

Table 3. Auxiliary scale menu

| Function group number | Function group name | Description |
|-----------------------|---------------------|-----------------------------|
| P1 | CAL | User calibration |
| P2 | rEAd | Readout parameters |
| P2 | Func | Working modes |
| P4 | Conn | Communication |
| P5 | ducE | Peripheral devices |
| P6 | Prnt | Printouts |
| P7 | Othr | Operation-related functions |
| P8 | InFo | Scale information |
| P9 | Unit | Units |

In order to navigate the auxiliary scales menu, utilize the keypad.

Table 4. Auxiliary scale menu navigation

| Key | Description |
|---|--|
|  +  | Press to enter the main menu |
|  +  | Press to: <ul style="list-style-type: none"> • Enter tare manually • Enter tare from tare database • Change value by 1 digit up • Scroll the menu up |
|  +  | Press to view date/time |
|  | Press to: <ul style="list-style-type: none"> • Scroll the menu down • Change current parameter value |
|  | Press to enter given submenu. Press to modify given parameter |
|  | Press to confirm modification |
|  | Press to: <ul style="list-style-type: none"> • Exit, function remains unmodified • Move one menu level up |

3. Weighing



3.1 Good weighing practice

To assure long-term operation and correct mass measurement, follow the rules presented below:



Table 5. Good weighing practices

| Recommendation | |
|--|--|
| Load the weighing pan steadily avoiding mechanical shocks | |
| Place weighed loads centrally on the weighing pan (eccentricity errors are specified by EN 45501 standard, point 3.6.2.) | |
| Do not apply concentrated force (total load in one point) | |
| Avoid side loading, in particular side shocks | |

3.2 Zeroing





- To zero mass indication press  key, during this process the weighing pan must be empty.
- With the zeroing of the scale, the pictograms  and  are displayed. The scale can only be zeroed when the indication is stable.
- Indication can be zeroed only within $\pm 2\%$ range of the maximum capacity. If the zeroed value is greater than $\pm 2\%$ of the maximum capacity, then the scale displays message **<Err2>**, and short sound signal is heard.

3.3 Taring

- To determine the net weight value, load the weighing pan with a package. Wait for the stable indication, , and press  key.
- The zero indication and the following pictograms are displayed: **Net** and .
- The scale has now been tared. Upon loading, net mass is displayed.

- Taring can be carried out repeatedly within the whole weighing range. Do not exceed the maximum capacity, i.e. sum of tare weight value and load weight value must be lower than the maximum capacity value.
- Upon unloading, the sum of tared masses with a minus sign is displayed. To return to zero point press  key.



3.3.1 Entering tare value manually

- Press  and  keys combination, tare value edit box is displayed.
- Enter tare value. To do so press  to set digit value (0 - 9) and  to select digit to be edited.
- Press  key to confirm, the scale returns to the weighing mode, modified tare value with '-' sign is displayed.
- You can enter tare value at any time during the weighing operation.

3.4 Units



<P9.Unit> parameter group enables change of start unit and temporary unit. The units can be changed during weighing or during other working modes operation. 'Parts Counting' and 'Percent Weighing' modes are exceptions.

3.4.1 Start unit

- Enter <P9.Unit/9.1.UnSt> submenu.
- Press  key, available units are displayed successively one by one. Available units are: g (gram), kg (kilogram), ct (carat), lb (pound).
- Select start unit and press  key. To return to home screen press  key.
- Upon restart, the scale runs with the set start unit.

3.4.2 Temporary unit

Temporary unit runs from the moment it is set to the scale shut-down and restart.

- Enter <P9.Unit/9.2.Unin> submenu.
- Press  key, available units are displayed successively one by one. Available units: g (gram), kg (kilogram), ct (carat), lb (pound).
- Select start unit and press  key. To return to home screen press  key.

4. Calibration



In order to ensure the highest weighing accuracy, it is recommended to periodically introduce corrective factor of indications to scale memory. This factor is a known reference weight which is used to perform a calibration of the scale.

Calibration is recommended to be carried out when:

- Prior to weighing.
- If long breaks between successive measuring series occurs.
- If the ambient temperature has changed dynamically.
- If the scale has been relocated.



4.1 External calibration

External calibration must be carried out using an external calibration weight of class F₂.

1. Enter <P1.CAL / 1.1.CA-E> submenu, the text <UnLoAd> will be displayed.
2. Remove any load from the weighing pan and press  key.
3. Mass of the empty weighing pan is determined; this is signaled with display of dash <- >.
4. Text <LoAd> is displayed along with required mass value, <20000g>.
5. Load the required mass value, press  key.
6. Weigh mass is determined; this is signaled with display of dash <- >. Once complete, text <UnLoAd> will be displayed.
7. Remove mass from weighing pan, scale returns to <P1.CAL / 1.1.CA-E> submenu.

4.2 User calibration

User calibration must be carried out using an external calibration weight of class F₂. The calibration weight value is specified by sure and must be of a mass equal or greater than 30% of maximum capacity.

1. Enter <P1.CAL / 1.2.CA-u> submenu, edit box for declaring weight mass is displayed (the mass value must be ≥ 30% of the maximum capacity value).
2. Enter weight mass value and press  key, the text <UnLoAd> will be displayed.
3. Remove any load from the weighing pan and press  key.
4. Mass of the empty weighing pan is determined; this is signaled with display of dash <- >.
5. Text <LoAd> is displayed along with user inputted mass value, i.e. <10000g>.
6. Load the required mass value, press  key.
7. Weigh mass is determined; this is signaled with display of dash <- >. Once complete, text <UnLoAd> will be displayed.
8. Remove mass from weighing pan, scale returns to <P1.CAL / 1.2.CA-u> submenu.



4.3 Calibration report

The calibration report is automatically printed (using scale-connected printer) at the end of each calibration process. To declare report content, go to <P6.1.CrEP> submenu.

5. Scale parameters

Scale parameters are set to adjust the weighing device to ambient conditions (filters) or individual needs (autozero, on/off, tare values memory). These parameters are to be found in <P2.rEAd> submenu.

5.1 Filter

1. Enter <P2.rEAd / 2.1.Fil> submenu.
2. Press  key, filter values are displayed successively one by one, where: **1** - Fast, **2** - Average, **3** - Slow.
3. Set respective value and press  key to confirm, next go to the home screen.

Note: The higher filter value, the longer the indication takes to stabilize.

5.2 Value release

Enter this parameter to adjust rate of stabilization of the measurement result. Depending on the selected option, weighing time is either shorter or longer.

1. Enter <P2.rEAd / 2.2.APPr> submenu.
2. Press key, filter values are displayed successively one by one, where: **F_P** – Fast and Reliable, **PrEc** - Reliable, **FASt** – Fast.
3. Set respective value and press key to confirm, next go to the home screen.

5.3 Ambient conditions

Parameter relating to ambient and environmental conditions of the workstation. Enter this parameter and set 'nStAb' value if the ambient conditions are unfavorable (air drafts, vibrations).

4. Enter <P2.rEAd / 2.3.Enut> submenu.
5. Press key, filter values are displayed successively one by one, where: **nStAb** – unstable, **StAb** – stable.
6. Set respective value and press key to confirm, next go to the home screen.

5.4 Autozero function

'Autozero' function has been designed to enable automatic control of zero indication. This guarantees precise weighing results. There are, however, some cases where this function can be a negative factor in the measuring process, e.g. very slow loading of the weighing pan (load adding, e.g. pouring, filling). In such case, it is recommended to disable the function.

1. Enter <P2.rEAd / 2.4.Aut> submenu.
2. Press key, filter values are displayed successively one by one, where: **YES** – Function enabled, **no** – Function disabled.
3. Set respective value and press key to confirm, next go to the home screen.

5.5 Tare entering mode

The tare is entered using and keys combination. There are two enter modes.





1. Enter <P2.rEAd / 2.6.ttr> submenu.
2. Press key, filter values are displayed successively one by one: **tArEH** -to enter tare value manually, **tArnn** – to enter tare value that is stored in scale memory.
3. Set respective value by using and keys.
4. Press key to confirm, next go to the home screen.

5.6 Tare value memory



It is possible to store 10 tare values in scale memory.

5.6.1 Entering tare value to scale memory

1. Enter <P2.rEAd / 2.7.tArn> submenu, name of tare no. 1 from tare database is displayed (<tArE 0>), to select a different record press key.

2. Select respective entry and press  key, tare value edit box is displayed.
3. Enter tare value, to do this press  to select digit to be edited and  to set digit value (0 - 9).
4. Press  key to confirm, <tArE 0> is displayed.
5. Press  to return to home screen.



5.6.2 Selecting tare value from the scale memory

1. Enter <P2.rEAd / 2.7.tArn> submenu, name of tare no. 1 from tare database is displayed (<tArE 0>), to select a different record press  key.
2. To select a tare value press  key.
3. The set tare value is displayed on the screen with a minus sign, **Net** symbol is shown in the upper-left corner of the screen.

Note: the tare value acquired from the weighing device memory is not remembered upon the weighing device restart.

5.7 Last digit



Function designed to disable display of the last weighing indication digit, this results with less accurate measurement.

1. Enter <P2.rEAd / 2.8.LdiG> submenu.
2. Press  key, filter values are displayed successively one by one, where: **ALAS** – Last digit always on, **nEur** – Last digit always off, and **uuSt** – Last digit on only when the weighing indications is stable.
3. Set respective value and press  key to confirm, next go to the home screen.

6. Communication

Communication between the scale and peripheral devices is established via the following ports: RS232 (1), USB type A, USB type B. To set the ports go to <P4.Conn> submenu.

6.1 RS232 (1) port settings

1. Enter <P4.Conn / 4.1.rS1> submenu.
2. Submenu <4.1.1.bAd> sets the baud rate. Press  key, and rates are displayed successively one by one: **2400, 4800, 9600, 19200, 38400, 57600, 115200 bit/s.**
3. Submenu <4.1.1.bAd> sets the baud rate. Press  key, and rates are displayed successively one by one: **2400, 4800, 9600, 19200, 38400, 57600, 115200 bit/s.**
4. Set respective value and press  key to confirm, next go to the home screen.

6.2 USB (A) port

USB port of type A is intended for:

- Operator's parameters export/import

- Weighing reports export
- Connecting scale to printer

6.3 USB (B) port

USB port of type B is intended for connecting the scale to a computer in order to make connection of scale to computer, it is necessary to install virtual COM port on the computer.

7. Peripheral devices



<P5.ducE> menu contains list of devices connecting with the scale.

7.1 Computer



<5.1.PC> submenu allows to:

- Select port to which the computer is connected
- Enable/disable continuous transmission
- Set frequency of printouts for continuous transmission

7.1.1 Port



1. Enter <P5.1.PC / 5.1.1.Prt> submenu.
2. Press  key, port options are displayed successively, where: **nonE** – none, **rs1** – RS232 (1), **USbb** – USB type B.
3. Set respective value and press  key to confirm, next go to the home screen.

7.1.2 Continuous transmission

1. Enter <P5.1.PC / 5.1.2.Cnt> submenu.
2. Press  key, transmission options are displayed successively, where: **nonE** – Continuous transmission disabled, **CntA** – Continuous transmission in basic unit, **Cntb** – Continuous transmission in current/temporary unit.
3. Set respective value and press  key to confirm, next go to the home screen.

7.1.3 Printout interval for continuous transmission

Parameter to set frequency of printout for continuous transmission. Printout interval is set in seconds, with 0.1 [s] accuracy within 0.1 [s] – 3600 [s] range.



1. Enter <P5.1.PC / 5.1.3.Int> submenu.
2. Enter transmission rate, to do this press  to select digit to be edited and  to set digit value (0 - 9).
3. Set respective value and press  key to confirm, next go to the home screen.

7.1.4 Printer

<5.2.Prtr> submenu allows to:

- Select port to which the printer is connected

7.1.5 Port



1. Enter <P5.2.Prtr / 5.2.1.Prt> submenu.
2. Press  key, options are displayed successively, where: **nonE** – No port selected, **rS1** – RS232 (1), **USbA** – USB type A which a printer can be connected, and **USbb** – USB type B which a computer can be connected.
3. Set respective value and press  key to confirm, next go to the home screen.

7.2 Additional display

<5.3.AdSP> submenu allows to:

- Select port to which the additional display is connected

7.2.1 Port

1. Enter <P5.3.AdSP / 5.3.1.Prt> submenu.
2. Press  key, options are displayed successively, where: **nonE** – No port selected, **rS1** – RS232 (1).
3. Set respective value and press  key to confirm, next go to the home screen.

8. Printouts

8.1 Calibration report

<P6.1.CrEP> is a group of parameters allowing to declare variables that are to be printed on the calibration report printout. Each variable allows for accessibility attribute: **YES** – print, **no** – do not print. Calibration report is automatically generated at the end of each calibration process.

Table 6. Calibration report variable list

| Submenu | Name | Description |
|---------|------|--|
| 6.1.1. | CtP | Calibration type |
| 6.1.2. | dAt | Calibration date |
| 6.1.3. | tin | Calibration time |
| 6.1.4. | ldb | Scale serial number |
| 6.1.5. | CdF | Difference between mass of a calibration weight measured during the last calibration and mass of the currently measured calibration weight |
| 6.1.6. | dSh | Dashed line separating printout data and signature fields |
| 6.1.7. | SiG | An area for the signature of an operator carrying out the calibration |

Figure 10. Calibration report example

```

-----Calibration Report-----
Calibration type           External
Date                       2016.10.15
Time                       12:39:23
Balance ID                 123456
Difference                  -0.02g
-----
Signature
.....

```

8.2 GLP printout

<P6.2.GLP> is a group of parameters allowing to declare variables that are to be printed on a weighing printout. Each variable allows for accessibility attribute: **YES** – print, **no** – do not print.

Table 7. GLP weighing printout variable list

| Submenu | Name | Description |
|---------|------|--|
| 6.2.1. | dAt | Weighing date |
| 6.2.2. | tin | Weighing time |
| 6.2.3. | n | Net weight value of performed weighing in a basic measuring unit |
| 6.2.4. | t | Tare weight value in a current unit |
| 6.2.5. | b | Gross weight value in a current unit |
| 6.2.6. | CrS | Current weighing result (net weight) in a current unit |
| 6.2.7. | CrP | The last adjustment report generated in accordance with settings declared for the adjustment report printout |

Figure 11. GLP printout example

```

Date           2016.10.15
Time           12:04:17
Net            49.98g
Tare           17.20g
Gross          67.18g



```

9. Miscellaneous parameters

<P7.Othr> is a group of parameters enabling to customize scale operation.

9.1 Backlight

Parameter allowing to change display brightness, the brightness can be changed within **0%** - **100%** range.

1. Enter <P7.Othr / 7.1.bLbt> submenu.
2. Press  key, options are displayed successively, where: **nonE** – Backlight off, **10** – Display brightness low limit value in [%], and **100** – Display brightness high limit value in [%].
3. Set respective value and press  key to confirm, next go to the home screen.

9.2 ‘Beep’ sound

Parameter allowing to enable/disable sound signal informing the operator about pressing panel key(s).

1. Enter **<P7.Othr / 7.2.bEEP>** submenu.
2. Press key, options are displayed successively, where: **no** – sound signal disabled, **YES** – sound signal enabled.
3. Set respective value and press key to confirm, next go to the home screen.

9.3 Automatic shutdown

Parameter allowing to set time interval, in [min], after which the weighing device shuts down automatically. If the indication is stable during the declared time interval, the device is shut down. Shutdown function is inactive, and the device cannot be turned off if any process is started or if you operate the menu.

1. Enter **<P7.Othr / 7.3.t1>** submenu.
2. Press key, options are displayed successively, where: **nonE** – Function disabled, **1, 2, 3, 5, 10**.
3. Set respective value and press key to confirm, next go to the home screen.

9.4 Date and time

Parameter allowing to set current date and time and to specify date and time format. Enter **<P7.Othr>** submenu and change the settings as desired. Refer to the below table:

Table 8. GLP date and time printout variable list

| Submenu | Description |
|------------|---|
| <7.4.SdAt> | Enter this parameter to set current date, where the date format is YYYY.MM.DD* |
| <7.5.Stnn> | Enter this parameter to set current time, where the time format is 24H** |
| <7.6.FdAt> | Enter this parameter to set date format. Available values: 1 - DD.MM.YYYY, 2 - MM.DD.YYYY, 3 - YYYY.MM.DD* (set by default), 4 - YYYY.DD.MM |
| <7.7.Ftin> | Enter this parameter to set time format. Values: 24H** (set by default), 12H** |

* Date format: Y – year, M – month, D – day.

** Time format: 12H – 12-hour format, 24H – 24-hour format.

9.5 Default user settings

Parameter allowing to restore default operator settings.

1. Enter **<P7.Othr / 7.8.dFL>** submenu, text **<Cont?>** is displayed (Continue?).
2. Press key to confirm. The process of restoring default settings starts, this is signaled with display of ‘dash’, <- >.
3. Upon process completion, **<7.8.dFLu>** submenu is displayed. Return to the home screen.

10. Scale Data

Scale data menu, <P8.InFo>, provides information on the weighing device and its program. The parameters serve informative purposes:

Table 9. Scale Data



| Submenu | Description |
|------------|--|
| <8.1.Idb> | Serial number of the scale |
| <8.2.PurS> | Program version |
| <8.4.PStP> | Settings printout. Enter the parameter to send scale settings to printer port (all parameters) |

11. Working modes – General information

The scale features the following working modes:

- Weighing
- Parts Counting
- +/- control
- Percent Weighing %
- Peak hold
- Totalizing
- Animal Weighing

11.1 Running working mode

1. Go to the home screen, press  key, name of the first available working mode is displayed.
2. Press  key, names of available working modes are displayed successively one by one.
3. Enter selected working mode, by pressing  key to confirm.

Note: The weighing device program has been designed to make the scale run, upon restart, with the latest operated working mode on.

11.2 Working mode local settings



Each working mode features specific (local) functions which enable customize scale operation. To go to local settings of each working mode, enter <P3.Func> submenu. Some special functions are available for all working modes, refer to the table below:

Table 10. Working mode settings

| | Accessibility | Save mode | Time interval | Lo threshold |
|--------------------|---------------|-----------|---------------|--------------|
| Weighing | 3.1.1.Acc | 3.1.2.Snn | 3.1.3.Int | 3.1.4.Lo |
| Parts Counting | 3.2.1.Acc | 3.2.3.Snn | 3.2.4.Int | 3.2.5.Lo |
| +/- control | 3.3.1.Acc | 3.3.2.Snn | 3.3.3.Int | 3.3.4.Lo |
| Percent Weighing % | 3.4.1.Acc | 3.4.3.Snn | 3.4.4.Int | 3.4.5.Lo |
| Peak Hold | 3.5.1.Acc | - | - | 3.5.2.Lo |
| Totalizing | 3.6.1.Acc | 3.6.2.Snn | 3.6.3.Int | 3.6.4.Lo |
| Animal Weighing | 3.7.1.Acc | - | - | 3.7.3.Lo |

11.2.1 Working mode accessibility

To enable/disable given working mode, press  key.

1. Enter **<P3.Func>** menu and select a given working mode.
2. Go to **<Acc>** function.
3. Press  key, parameter values are displayed successively one by one, where: **YES** – working mode enabled, **no** – working mode disabled.
4. Press  key to confirm, next return to home screen.

11.2.2 Save mode

Parameter allowing to set mode of sending data from the weighing device to a peripheral device.





1. Enter **<P3.Func>** menu and select a given working mode.
2. Go to **<Snn>** function.
3. Press  key, parameter values are displayed successively one by one, where:

Table 11. Save mode options

| Option | Description |
|--------|---|
| StAb | Manual printout of stable weighing result. Upon pressing  key at the moment when the result is unstable (no  pictogram displayed), the program first waits for the stability condition to be met, only then the printout is carried out |
| nStAb | Manual printout of each weighing result. In case of unstable indication, <?> sign is displayed in front of the 'mass frame' |
| rEPL | Automatic printout of the first stable weighing result above <Lo> threshold (to set <Lo> threshold go to <Lo> parameter) |
| rEPLi | Automatic printout with time interval set in [min] (to set the interval go to <Int> parameter) |

4. Press  key to confirm, next return to home screen.

11.2.3 Automatic printout interval

Parameter enabling to set frequency of an automatic printout. Printout interval is set in minutes with 1 [min] accuracy within 1 [min] – 1440 [min] range.

1. Enter **<P3.Func>** menu and select a given working mode.
2. Enter **<Int>** function, window for enter **time interval** value is displayed.
3. Press  key to confirm, next return to home screen.

11.2.4 Lo threshold

<Lo> parameter allows to configure the function of automatic operation. The next measurement is saved only when mass indication gets below the set net value of **Lo threshold** parameter.

1. Enter **<P3.Func>** menu and select a given working mode.
2. Enter **<Lo>** function, window for enter **Lo threshold** value is displayed.
3. Enter respective value and press  key to confirm, next return to home screen.

12. Working mode – Weighing

<UUGG> is a standard working mode to carry out the weighing operation along with record of the result to the database.

12.1 Local settings

To go to local settings, enter **<3.1.UUGG>** submenu.

Table 12. Weighing – Local settings

| Submenu | Setting |
|-----------|----------------------------|
| 3.1.1.Acc | Working mode accessibility |
| 3.1.2.Snn | Save mode |
| 3.1.3.Int | Time interval |
| 3.1.4.Lo | Lo threshold |

13. Working mode – Parts Counting

Parts Counting is a working mode enabling to determine quantity of small pieces of the same mass, which determination is done on the basis of mass of sample piece (single part), and where the sample piece mass (single part mass) is determined using the weighing device.

13.1 Local settings



To go to local settings, enter **<3.2.PcS>** submenu.

Table 13. Parts Counting – Local settings

| Submenu | Setting |
|-----------|----------------------------|
| 3.2.1.Acc | Working mode accessibility |
| 3.2.2.UUt | Operation mode |
| 3.2.3.Snn | Save mode |
| 3.2.4.Int | Time interval |
| 3.2.5.Lo | Lo threshold |

13.1.1 Working mode selection

Parameter allowing to select method of determination of sample piece mass.





1. Enter <3.2.PcS / 3.2.2.UUt> submenu.
2. Go to <Acc> function.
3. Press  key, parameter values are displayed successively one by one, where: **S_S** – Select to set sample mass by determining mass of a single part, **Suu** – Select to set sample mass by entering mass of a single part.
4. Enter respective value and press  key to confirm, then continue weighing.

13.2 Setting reference sample mass by entering mass of a single part

1. Enter <3.2.PcS / 3.2.2.UUt> submenu, set <Suu> value.
2. Enter <PcS> working mode (Parts Counting), first, text <Set_Ut> is displayed for 1s, next you see a window for entering mass value of a single part.
3. Enter respective value and press  key to confirm, the home screen is displayed automatically along with the quantity of parts loaded onto the weighing pan (pcs).

Note: If the value of entered single part mass is greater than max capacity value, then message <Err Hi> is displayed.

13.3 Setting reference sample mass by determining mass of a single part

1. Enter <3.2.PcS / 3.2.2.UUt> submenu, set <S_S> value.
2. Enter <PcS> working mode (Parts Counting), first, text <Set_Ut> is displayed for 1s, next you see a window for entering mass value of a single part.
3. Press  key to select one of the following options: **10** – 10 pieces, **20** – 20 pieces, **50** – 50 pieces, **100** – 100 pieces, **0000** – Custom reference sample quantity to enter required value.
4. Select respective option and press  key to confirm, first, text <LoAd> is displayed for 1 second, next you see a weighing window.
5. If the parts are to be weighed in a container, first put the container on a weighing pan and tare it.
6. Load the weighing pan with the declared amount of parts. When the indication is stable ( pictogram is displayed), press  key to confirm the mass.
7. Single part mass is calculated automatically, the quantity of parts (pcs) is displayed.

Note: Total weight value of all parts loaded onto the weighing pan cannot be greater than the max capacity value.

Note: Single part mass value must be equal or greater than 0.1 of the reading unit. Unless this condition is met, the weighing device displays a message <ErrLo>.

Note: In the course of parts quantity determination it is necessary to wait for a stable measurement  before confirming the declared quantity value.

14. Working mode – +/- control

+/- control is working mode enabling to enter check weighing threshold values (**Min**, **Max**).



14.1 Local settings

To go to local settings, enter **<3.3.HiLo>** submenu.

Table 14. +/- control – Local settings

| Submenu | Setting |
|-----------|----------------------------|
| 3.3.1.Acc | Working mode accessibility |
| 3.3.2.Snn | Save mode |
| 3.3.3.Int | Time interval |
| 3.3.4.Lo | Lo threshold |

14.2 Declaring check weighing thresholds

1. Enter **<HiLo>** working mode (+/- control), first, text **<SEt Lo>** is displayed for 1 s, next you see a window for declaring low weighing threshold (Min).
2. Enter a respective value and press  key to confirm, first, text **<SEt Hi>** is displayed for 1 second, next you see a window for declaring high weighing threshold (Max).
3. Enter respective value and press  key for confirmation, working mode's home screen is displayed along with the declared threshold value, where: **Min** – Load mass lower than low weighing thresholds, **Ok** – Load mass within weighing thresholds, **Max** – Load mass greater than high weighing threshold.

Note: If the entered low threshold value (Min) is greater than the high threshold value (Max), **<Err Lo>** error is displayed.

Note: If the entered high threshold value (Max) is greater than the maximum capacity value, **<Err Hi>** error is displayed.

15. Working mode – Percent Weighing

Percent Weighing is a working mode enabling to compare measured load mass with the reference sample mass. The result is expressed in [%]. Reference sample mass can be either determined by weighing or entered to weighing device memory by an operator.

15.1 Local settings



To go to local settings, enter **<3.4.dEu>** submenu.

Table 15. Percent Weighing - Local settings



| Submenu | Setting |
|-----------|----------------------------|
| 3.4.1.Acc | Working mode accessibility |
| 3.4.2.UUt | Operation mode |
| 3.4.3.Snn | Save mode |
| 3.4.4.Int | Time interval |
| 3.4.5.Lo | Lo threshold |

15.1.1 Working mode selection

Parameter allowing to select method of determination of reference sample mass.

1. Enter <3.4.dEu / 3.4.2.UUt> submenu.
2. Press  key, parameter values are displayed successively one by one, where: **S_S** – Select to set sample mass by determining the mass value, **Suu** – Select to set sample mass by entering the mass value.
3. Enter respective value and press  key to confirm, then continue to home screen.

15.2 Reference mass determined by weighing

1. Enter <3.4.dEu / 3.4.2.UUt> submenu, set <S_S> value.
2. Enter <dEu> working mode (Percent Weighing), first, text <LoAd> is displayed for 1s, next you see weighing result window.
3. Load the weighing pan with the reference sample. When the indication is stable ( pictogram is displayed) press  key to confirm the mass.
4. Mass of the weighed load is automatically set as reference sample mass, the home screen is displayed along with **100.000%** value.

15.3 Reference sample mass by determining mass of a single part

1. Enter <3.4.dEu / 3.4.2.UUt> submenu, set <Suu> value.
2. Enter <dEu> working mode (Percent Weighing).
3. First, text <Set_Ut> is displayed for 1s, next you see a window for declaring mass of the reference sample.
4. Enter respective value and press  key to confirm. The home screen is displayed automatically with **0.000%** value.

Note: If the value of entered reference sample mass is greater than the max capacity value, then message <Err Hi> is displayed.

16. Working mode – Peak Hold

Peak Hold is a working mode allowing to snap value of maximum force applied to the weighing pan during one weighing process.

16.1 Local settings

To go to local settings, enter <3.5.toP> submenu.

Table 16. Peak Hold – Local settings

| Submenu | Setting |
|-----------|----------------------------|
| 3.5.1.Acc | Working mode accessibility |
| 3.5.2.Lo | Lo threshold |

16.2 Peak Hold operation

1. Enter **<3.5.toP / 3.5.2.Lo>** submenu, set **<Lo>** parameter value (Lo threshold) after exceeding of which maximum force is to be registered.
2. Enter **<toP>** working mode (Peak Hold). From now on the scale registers and holds every single weighing which is above the **Lo threshold**, and which is higher than the result of the previous Peak Hold. Snapped Peak Hold value is signaled by **<Max>** pictogram at the top of the screen.
3. The start of the next process of Peak Hold measurement is possible only after removing the load from the weighing pan and pressing  key.
4. This causes returning to the home screen of **<toP>** mode. Pictogram **<Max>** is automatically deleted.

17. Totalizing

Totalizing is a working mode enabling to sum mass of all weighed ingredients, and to print (via scale-connected printer) the total mass value. The pictogram allows to sum up to 30 weighing (ingredients) maximum within one process.



17.1 Local settings

To go to local settings, enter **<3.6.Add>** submenu.

Table 17. Totalizing – Local settings

| Submenu | Setting |
|-----------|----------------------------|
| 3.6.1.Acc | Working mode accessibility |
| 3.6.2.Snn | Save mode |
| 3.6.3.Int | Time interval |
| 3.6.4.Lo | Lo threshold |

17.2 Totalizing operation

1. Enter **<Add>** working mode (Totalizing), blinking “▲” pictogram is displayed.
2. If the ingredients are to be weighed in a container, first put the container on a weighing pan and tare it.
3. Load the weighing pan with the ingredient no. 1. When the indications are stable ( pictogram is displayed), press  key to confirm the mass.
4. Unload the weighing pan, **ZERO** is displayed, “▲” marker starts blinking again.
5. Load the weighing pan with the ingredient no.2, wait for a stable weighing result and press  key.
6. Total mass value of ingredient no. 1 and 2 is displayed, now the “▲” pictogram is displayed continuously.



- In order to finish the process, press  key, text <Prnt?> (Print?) is displayed.
- Press  key, total mass value of all recorded weighing is printed on a scale-connected printer.

Figure 12. Totalizing printout example

| | |
|--------|-----------|
| (1) | 13.500 g |
| (2) | 14.400 g |
| (3) | 9.700 g |
| (4) | 100.500 g |
| (5) | 4.000 g |
| (6) | 8.200 g |
| (7) | 20.800 g |
| (8) | 5.800 g |
| ----- | |
| Total: | 176.900 g |

- In order to print the report once again press  key.
- To exit “report printout mode” press  key. As a result, the home screen of <Add> working mode is displayed and all the data get zeroed automatically.

Note: If the display capacity is exceeded (i.e. there is not enough space for all the digits of the weighing result) <Hi> error is displayed. In such a case either remove the ingredient from a weighing pan and finish the totalizing process or place load of a lower weight value on the weighing pan.

18. Working mode – Animal Weighing

Animal Weighing is a working mode enabling to weigh products that disrupt efficient establishing of stability. It is mostly intended to measure weight of animals.



18.1 Local settings



To go to local settings, enter <3.7.AnLS> submenu.

Table 18. Animal Weighing – Local settings

| Submenu | Setting |
|------------|----------------------------|
| 3.7.1.Acc | Working mode accessibility |
| 3.7.2. Aut | Averaging time |
| 3.7.3.Lo | Lo threshold |

18.2 Animal Weighing operation

- Enter <AnLs> working mode (Animal Weighing).
- First, text <tinnE> is displayed for 1s, next you see a window for setting duration (in seconds) of animal weighing.
- Press  key, parameter values are displayed successively one by one, where: 5[s], 10[s], 20[s], 30[s], 40[s], 50[s], 60[s].
- Set the respective value, press  key to confirm, weighing result window with **A** letter is displayed.

5. Load the weighing pan with an animal.
6. On exceeding the set mass value of **<Lo threshold>** parameter, animal weighing starts, this is signaled with display of 'dash' <- >.
7. Upon process completion, mass value of an animal is snapped and displayed together with **OK** pictogram in the upper part of the display. The snapped mass value is sent to a scale-connected printer.
8. Press  key to restart animal weighing.
9. Press  key to reprint the snapped mass value.
10. Upon unloading of the weighing platform, the weighing result window with letter **A** is displayed. The scale can be loaded with an animal again.

19. Maintenance

In order to ensure safety in the course of cleaning, it is necessary to disconnect the device from the mains. With this condition met, uninstall the weighing pan and other detachable scale components.

Note: *Cleaning the weighing pan while still installed may cause damage of the measuring system.*

19.1 Cleaning ABS components

To clean dry surfaces and avoid smudging, use clean non-coloring cloths made of cellulose or cotton. You can use a solution of water and detergent (soap, dishwashing detergent, glass cleaner). Gently rub the cleaned surface and let it dry. Repeat cleaning process if needed.

In the case of hard to remove contamination, e.g. residues of adhesive, rubber, resin, polyurethane foam etc., you can use a special cleaning agent based on a mixture of aliphatic hydrocarbons that do not dissolve plastics. Before using the cleanser for all surfaces, we recommend carrying out tests. Do not use cleansers containing abrasive substances.

19.2 Cleaning stainless steel components

Avoid using cleansers containing any corrosive chemicals, e.g. bleach (including chlorine). Do not use cleansers containing abrasive substances. Always remove the dirt using microfiber cloth to avoid damage of protective coating.

In case of a daily maintenance:

- Remove the dirt using cloth dipped in warm water.
- For best results, add a little bit of dishwashing detergent.

19.3 Cleaning aluminum components

While cleaning aluminum components use products acid by nature, e.g. spirit vinegar, lemon. Do not use cleansers containing abrasive substances. Avoid using hard brush, this may cause scratches. It is recommended to use microfiber cloth.

While polishing the surface use circular movements. Use clean, dry cloth to make the surface shine.

20. Mechanical design

20.1 Dimensions

Figure 13. Scale dimensions

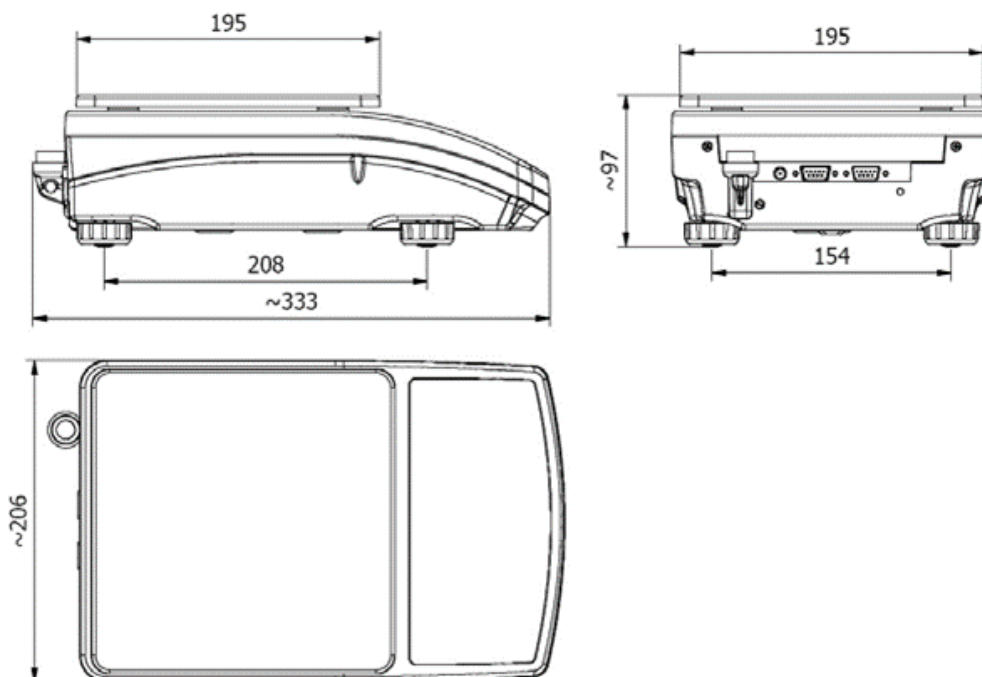

20.2 Connectors arrangement

Figure 14. Scale connectors

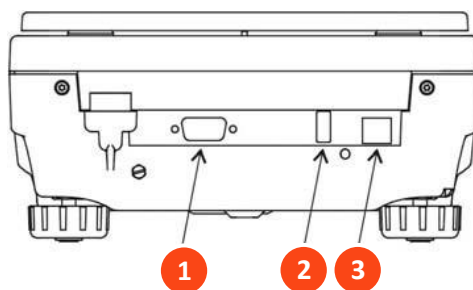

Connectors view

1. RS232 connector
2. USB A "host"
3. USB B "device"

Figure 15. RS-232 connector

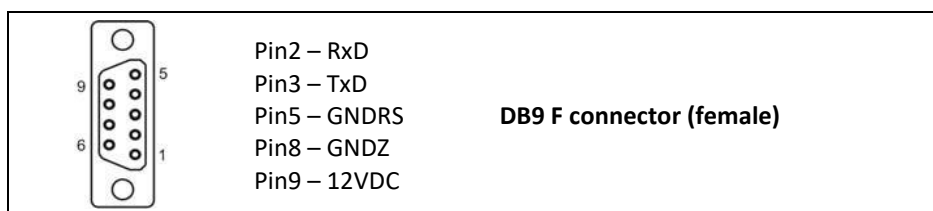

21. Troubleshooting

Table 19. Troubleshooting suggestions

| Problem | Cause | Solution |
|--|--|---|
| The scale switches off automatically | <7.3.t1> parameter set to value enforcing scale shut-down after particular time interval | Go to 'Othr' menu, set <7.3.t1> parameter to 'nonE' value |
| During switching on, message 'LH' is displayed | Weighing pan loaded during the switching-on process | Unload the weighing pan. Zero indication is displayed |

22. Error messages

Table 20. Error messages

| Error | Cause |
|----------|--|
| -Err 2- | Value beyond zero range |
| -Err 3- | Value beyond tare range |
| -Err 4- | Calibration weight or start mass out of range ($\pm 1\%$ for calibration weight, ± 10 for start mass) |
| -Err Lo- | Determined mass of single part in 'Parts Counting' mode too small Value of 'Min' threshold is greater than value of 'Max' threshold in '+/- control' mode |
| -Err Hi- | Entered value of single part greater than maximum capacity in 'Parts Counting' working mode Entered value of 'Max' threshold greater than maximum capacity in '+/- control' mode Entered reference mass greater than maximum capacity in 'Percent Weighing' mode |
| -Err 8- | Time of the following operations exceeded: taring, zeroing, start mass determining, calibration |
| -null- | Zero value from the converter |
| -FULL- | Weighing range exceeded |
| -LH- | Start mass error, indication out of range ($\pm 10\%$ of start mass) |
| -Hi- | Display range of total mass on scale display exceeded in 'Totalizing' mode |

23. Index

| | | | |
|------------------------------|--------------------|----------------------|--------------------------------|
| Calibration..... | 13, 14, 18, 19, 31 | Maintenance..... | 29 |
| Connectors..... | 30 | Note..... | 14, 16, 21, 24, 25, 26, 28, 29 |
| Devices..... | 11, 16, 17 | Operating..... | 11 |
| Error..... | 31 | Parameters..... | 11, 14, 16, 18, 19, 21 |
| Good weighing practices..... | 12 | Precautions..... | 7 |
| Installation..... | 8 | Troubleshooting..... | 31 |